

RDN 60 TI

Vue 3D

DT89_1

Date :
28/04/2015

Dessiné par :
R.L

Approuvé par :
R.Schoenberger

Date :
28/04/2015

Indice
A

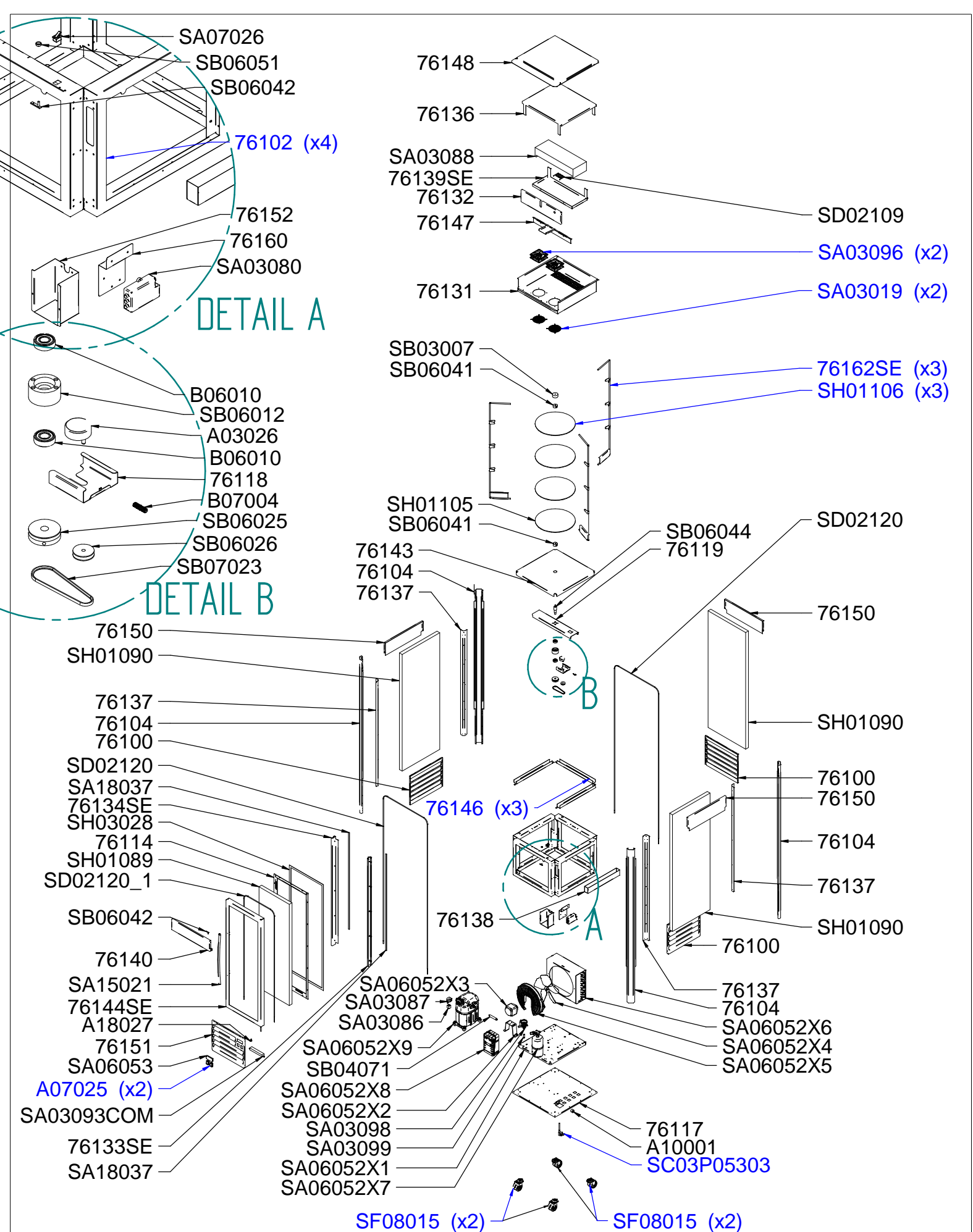

| | | | | | |
|--------|----------------------|----------------------|----------------|----------------------|--------------------|
| DT89_1 | Date : 28/04/2015 | Dessiné par : R.L | Approuvé par : | Date : 28/04/2015 | Indice A |
|--------|----------------------|----------------------|----------------|----------------------|--------------------|

| CODE | QTE | PIECE | SPARE PART |
|----------------|----------|--|--|
| 76100 | 3 | GRILLE CADRE RD 60 F/RD 60 T | FRAME GRID RD 60 F/RD 60 T |
| 76102 | 4 | CADRE RD 60 F/RD 60 T | FRAME RD 60 F/RD 60 T |
| 76104 | 4 | MONTANT EXTERIEUR RD 60F/T RDN 60 | EXTERIOR UPRIGHT RD 60/RDN 60 |
| 76114 | 1 | CONTRE PORTE RD 60 F/RD 60 T | INSIDE DOOR FRAME RD 60 F/RD 60 T |
| 76117 | 1 | SOCLE RDS 60 | BASE RDS 60 |
| 76118 | 1 | 0 | 0 |
| 76119 | | TRAVERSE MOTEUR RD 60 T | |
| 76131 | 1 | REFLECTEUR RDN 60 | REFLECTOR RDN 60 |
| 76132 | 1 | 0 | 0 |
| 76133SE | 1 | S/E CONTOUR PORTE EXT DROIT RDN 60 | RIGHT OUTSIDE DOOR FRAME ASSEMBLY RDN 60 |
| 76134SE | 1 | S/E CONTOUR PORTE EXT GAUCHE RDN 60 | LEFT OUTSIDE DOOR FRAME ASSEMBLY RDN 60 |
| 76136 | 1 | CACHE EVAPORATEUR RDN 60 | EVAPORATOR COVER RDN 60 |
| 76137 | 4 | EQUERRE MONTANT RDN 60 | SIDE BRACKET RDN 60 |
| 76138 | 1 | BAC A EAU RDN 60 | WATER CONTAINER RDN 60 |
| 76139SE | 1 | S/E BAC EVAPORATEUR RDN 60 | EVAPORATOR TRAY RDN 60 |
| 76140 | 1 | BANDEAU FACADE RDN 60 | TOP FRONT REAR RDN 60 |
| 76143 | 1 | PLATEAU RDN 60 | TRAY RDN 60 |
| 76144SE | 1 | S/E PORTE RDN 60 | DOOR RDN 60 |
| 76146 | 3 | TRAVERSE CADRE RDN 60 | FRAME CROSSPIECE RDN 60 |
| 76147 | 1 | GOUTTIERE EVAPORATEUR RDN 60 | EVAPORATOR GUTTER RDN 60 |
| 76148 | 1 | CAPOT RDN 60 | TOP CASING RDN 60 |
| 76150 | 3 | BANDEAU LATERAL RDN 60 | TOP SIDE REAR RDN 60 |
| 76151 | 1 | GRILLE CADRE COMPOSANT RDN 60 | CONTROL PANEL FRAME GRID RDN 60 |
| 76152 | 1 | CAPOT CORDON RD 60/RDN 60/RDS 60 | CORD COVER RD 60/RDN 60/RDS 60 |
| 76160 | 1 | SUPPORT BOITE RACCORDEMENT RDN 60 | CONNECTION BOX HOLDER RDN 60 |
| 76162SE | 3 | S/E BARRE TOURNANTE RDN 60 T | SWIVEL BARS RDN 60 T |
| A03026 | 1 | MOTEUR | MOTOR |
| A07025 | 2 | INTERRUPTEUR NOIR ETANCHE BIP 20A/250V | BLACK SWITCH BIP 20A/250V |
| A10001 | 1 | SERRE CABLE PA 107 | CORD CLOSER PA 107 |
| A18027 | 1 | DIODE 20 A CT 3000/CT 540 /GYROS | DIODE FOR CT540/CT300V GYROS |
| B06010 | 2 | ROULEMENT | BEARING |
| B07004 | 1 | RESSORT | SPRING |
| SA03019 | 2 | GRILLE VENTILATEUR | VENTILATOR GRID |
| SA03080 | 1 | BOITIER RACCORDEMENT ELECTRIQUE | ELECTRICAL CONNECTION BOX |
| SA03086 | 1 | ELECTROVANE RDN 60 | ELECTROGATE RDN 60 |
| SA03087 | 1 | BOBINE POUR ELECTROVANE RDN 60 | COIL FOR ELECTROGATE RDN 60 |
| SA03088 | 1 | EVAPORATEUR RDN 60 | EVAPORATOR RDN 60 |
| SA03093COM | 1 | ALIMENTATION LED ASSEMBLEE | LED ALIMENTATION ASSEMBLY |
| SA03096 | 2 | VENTILATEUR HELICOIDE RD 60 NEGATIVE | VENTILATOR RDN 60 |
| SA03098 | 1 | DETENDEUR RDN 60 | REGULATOR RDN 60 |
| SA03099 | 1 | ORIFICE 02T2 PLAT RDN 60 | ORIFICE 02T2 RDN 60 |
| SA06052 | 1 | GROUPE FROID RDN 60 | COOLING UNIT RDN 60 |
| SA06052X1 | 1 | SUPPORT COMPRESSEUR RDN 60 | COMPRESSOR HOLDER RDN 60 |
| SA06052X2 | 1 | SUPPORT MOTEUR RDN 60 | MOTOR HOLDER RDN 60 |
| SA06052X3 | 1 | MOTEUR RDN 60 | MOTOR RDN 60 |
| SA06052X4 | 1 | HELICE | FAN BLADE |
| SA06052X5 | 1 | CARTER | FAN BRACKET |
| SA06052X6 | 1 | CONDENSEUR | CONDENSER |
| SA06052X7 | 1 | RESERVOIR LIQUIDE RDN 60 | LIQUID RESERVOIR RDN 60 |
| SA06052X8 | 1 | BOITIER ELECTRIQUE RDN 60 | ELECTRICAL BOX RDN 60 |
| SA06052X9 | 1 | COMPRESSEUR | COMPRESSOR |
| SA06053 | 1 | THERMOSTAT ELECTRONIQUE RDN 60 | ELECTRONIC THERMOSTAT RDN 60 |
| SA07026 | 1 | MICROSWITCH | MICROSWITCH |
| SA15021 | 1 | POIGNEE ANODISEE | ANODIZED HANDLE |
| SA18037 | 2 | LED Lg= 1100 mm | LED Lg= 1100 mm |
| SB03007 | 1 | PALIER PLASTIQUE | PLASTIC BEARING |
| SB04071 | 1 | DESHYDRATEUR CUIVRE SM 2/15 6.5-6.5 | COPPER DEHYDRATOR SM 2/15 6.5-6.5 |
| SB06012 | 1 | SUPPORT ROULEMENT | BALL BEARING SUPPORT |
| SB06025 | 1 | POULIE D 60x18 | BLOCK D 60x18 |
| SB06026 | 1 | POULIE D40x10 | BLOCK D40x10 |
| SB06023 | 1 | SUPPORT ROULEMENT | BALL BEARING SUPPORT |
| SB06041 | 2 | AXE TOURELLE | AXLE |
| SB06042 | 2 | AXE | HINGE |
| SB06044 | 2 | AXE DE ROTATION | ROTATION AXLE |
| SB06051 | 1 | BAGUE POUR PORTE RDN 60 | RING DOOR RDN 60 |
| SB07023 | 1 | COURROIE VT 350/550/RD 60 T | BELT VT 350/550/RD 60 T |
| SC03P05303 | 1 | CORDON | CORD |
| SD02109 | 1 | RESISTANCE CHAUFFANTE 800 W 230 V | HEATING ELEMENT 800 W 230 V |
| SD02120 | 2 | CORDON CHAUFFANT RDS 60 | HEATING CABLE RDS 60 |
| SD02120_1 | 1 | CORDON CHAUFFANT RDS 60 | HEATING CABLE RDS 60 |
| SF08015 | 4 | ROUE | WHEEL |
| SH01089 | 1 | PORTE TRIPLE VITRAGE 400X1155 RDN 60 | TRIPLE GLASS DOOR RDN 60 |
| SH01090 | 3 | COTE TRIPLE VITRAGE 495X1330 RDN 60 | TRIPLE GLASS SIDE RDN 60 |
| SH01105 | 1 | VITRE PLATEAU MIROIR | MIRROR GLASS SHELF |
| SH01106 | 3 | VITRE PLATEAU | GLASS SHELF |
| SH03028 | 1 | JOINT MAGNETIQUE RDN-RDS 60 | MAGNETIC SEAL RDN-RDS 60 |

RDN 60 TI

Nomenclature

DT89_1

Date :
28/04/2015

Dessiné par :
R.L

Approuvé par :
J.Godéré

Date :
28/04/2015

Indice
A

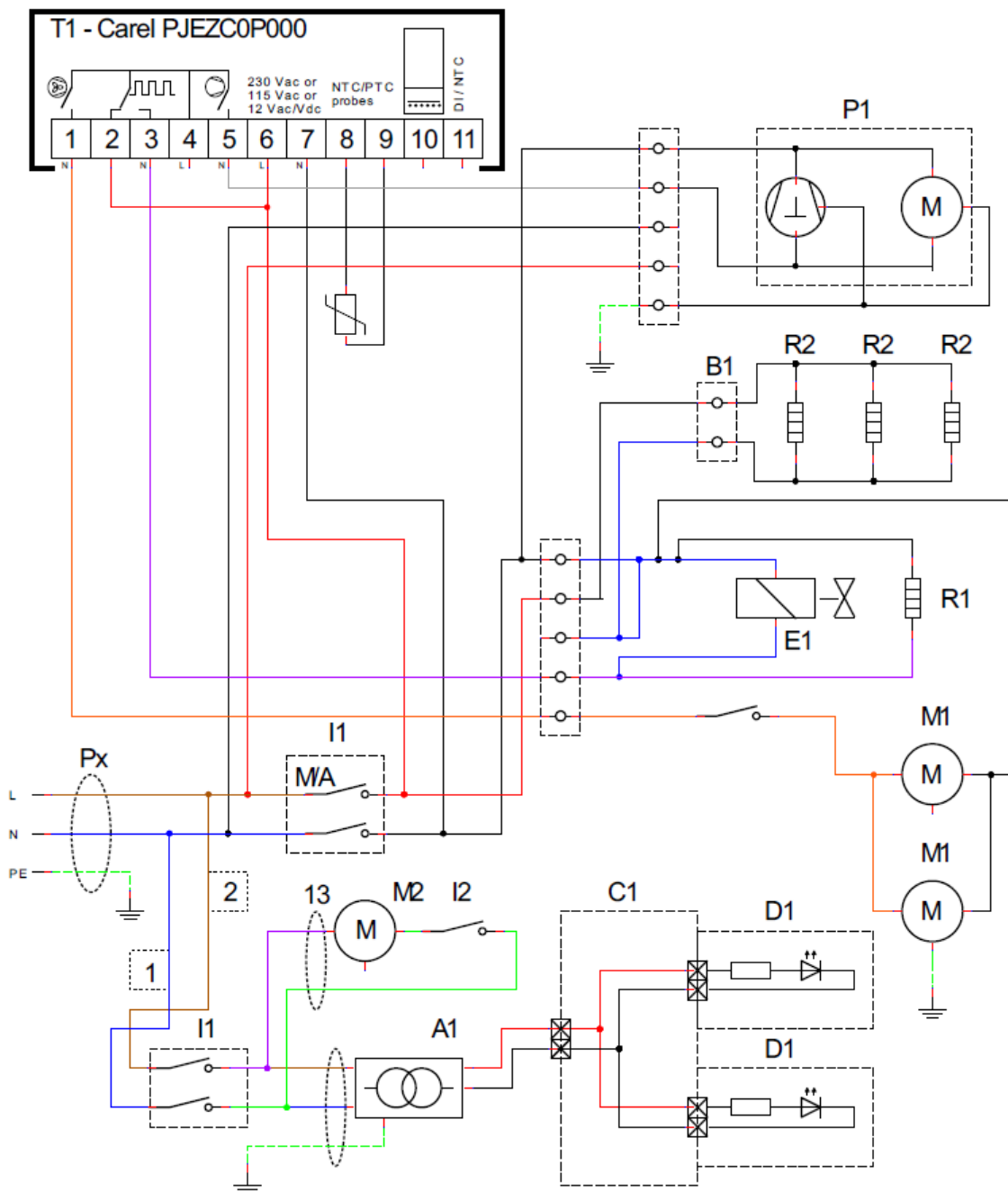

| ID | Reference | Designation | Qty |
|----|-----------------|---|-----|
| Px | cf nomenclature | Cordon d'alimentation / Power supply cable | 1 |
| I1 | A07025 | Interrupteur Bipolaire / Bipolar switch 20A/250V | 2 |
| I2 | SA07026 | Microswitch | 1 |
| T1 | SA06053 | Thermostat électronique CAREL / CAREL Electronic thermostat | 1 |
| P1 | SA06052 | Groupe froid / Condensing unit CAJT 2446ZBR | 1 |
| M1 | SA03096 | Moteur de ventilateur / Ventilator motor | 2 |
| M2 | A03026 | Moteur / Motor NTY49-II | 1 |
| R1 | SD02109 | Résistance chauffante / Heating element 800W | 1 |
| R2 | SD02120 | Cordon chauffant / Heating element | 3 |
| E1 | SA03086 | Electrovanne / Solenoid valve | 1 |
| B1 | SA03092 | Bornier / Terminal | 1 |
| A1 | SA03093COM | Alimentation Led / Led power supply | 1 |
| C1 | SA18040 | Adaptateur / Adaptor JST - 6.35 L=150mm | 1 |
| D1 | SA18037 | LED L=1100mm | 2 |
| na | SC02208 | Câblage / Wiring harness | 1 |
| 13 | SC02239 | Câble/ Cable H05 VK1 L=800mm | 1 |

RDN 60 TI

Schéma électrique

DT89_1

Date :
28/04/2015

Dessiné par :
R.L

Approuvé par :
Damien L.

Date :
28/04/2015

Indice
A

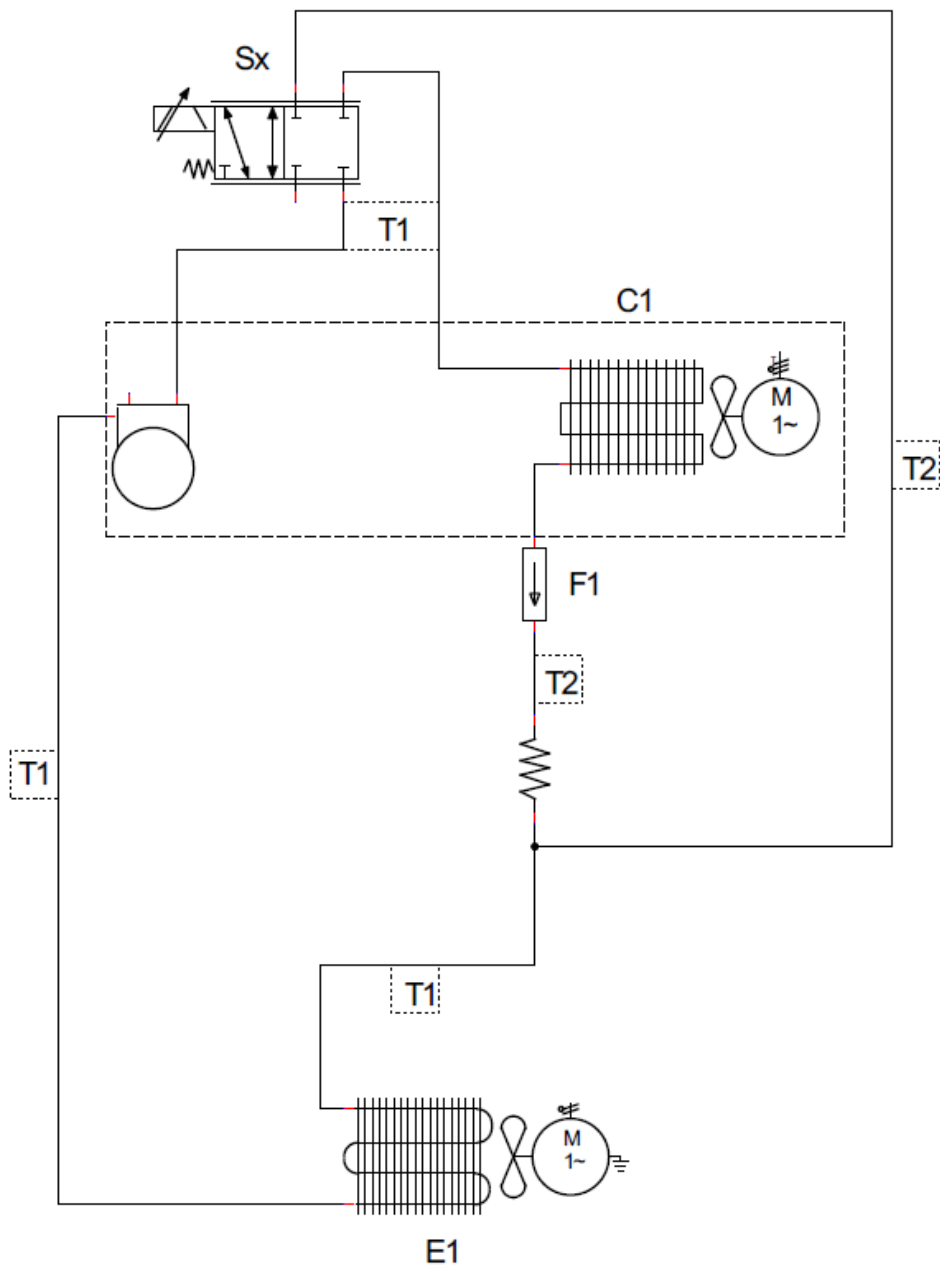

| ID | Reference | Designation | Qty |
|----|-----------|--|-----|
| C1 | SA06052 | Groupe froid / Condensing unit CA.JT 2446ZBR | 1 |
| F1 | SB04071 | Deshydrateur / Deshydrator SM2/15 6.5-6.5 | 1 |
| E1 | SA03088 | Evaporateur / Evaporator | 1 |
| S1 | SA03086 | Electrovanne / Solenoid valve | 1 |
| D1 | SA03098 | Détendeur / Pressure relief valve | 1 |
| T1 | SB04032 | Tube cuivre / Copper pipe 3/8 | 3 |
| T2 | SB04029 | Tube cuivre / Copper pipe 1/4 | 2 |
| NA | SE02117 | Gaz réfrigérant / Refrigerant gas R-404 | NA |

RDN 60 TI

Schéma frigorifique

DT89_1

Date :
28/04/2015

Dessiné par :
R.L

Approuvé par :
Damien L.

Date :
28/04/2015

Indice
A

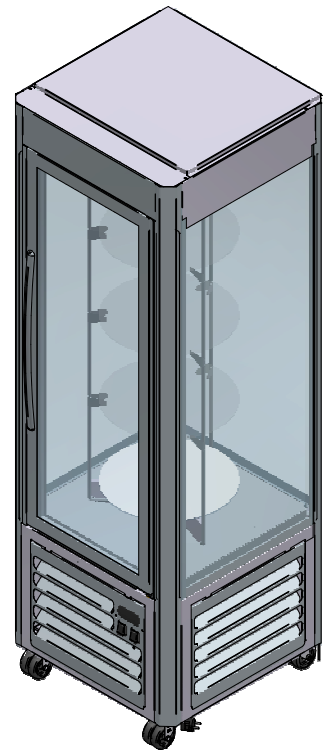
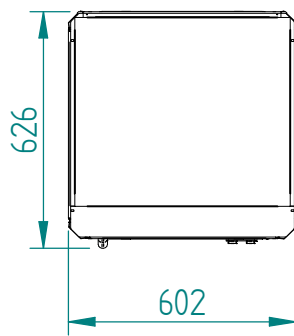
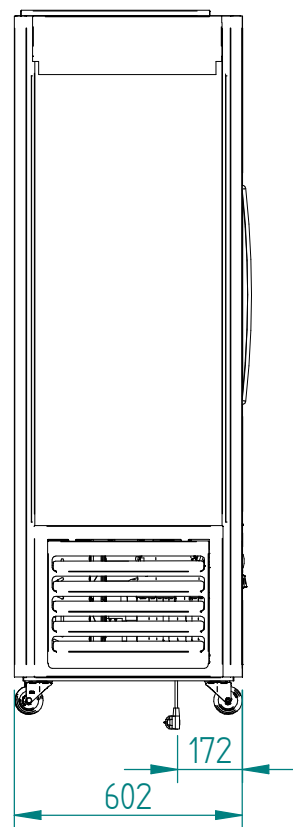
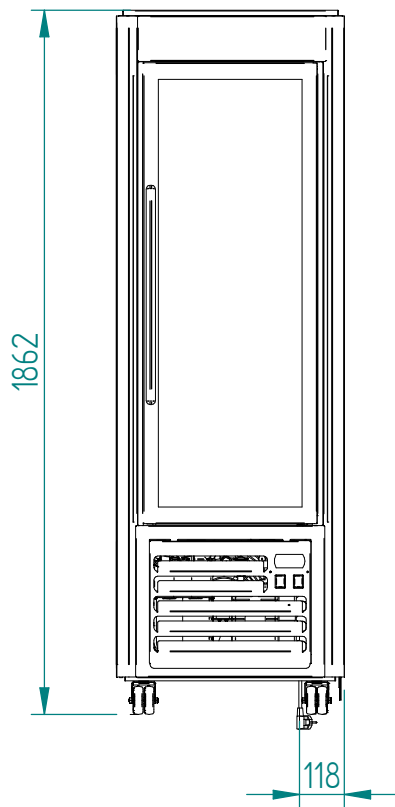

RDN 60 TI

Mise en plan

DT89_1

Date :
28/04/2015

Dessiné par :
R.L

Approuvé par :

Date :

Indice
A

| Produit concerné : | |
|--------------------|------------------|
| Code | Cordon / Cord |
| P05303A01 | SC03024 |
| P05303A03 | SC03024 + A16008 |
| P05303A04 | SC03024 |
| P05303A08 | SC03024 + A16016 |
| P05303F01 | SC03024 |

RDN 60 TI

Cadran

DT89_1

Date :
28/04/2015

Dessiné par :
R.L

Approuvé par :
J.Godéré

Date :
28/04/2015

Indice
A